

(ALL DIMENSIONS ARE IN mm)

NOTE: 1. DRAWING APPROVAL SUBJECT TO VALID TYPE TEST  
REPORTS, TO BE CHECKED DURING ACCEPTANCE TESTS  
2. FOR EPC CONTRACTS ONLY

## 400KV BAY MARSHALLING KIOSK

END USER	: M/s. APTRANSCO	
CUSTOMER	: AS APPLICABLE	
PURCHASE ORDER No.	: AS APPLICABLE	<b>Chief Engineer/Projects</b>
QTY	: AS APPLICABLE	<b>APTRANSCO/VS/Vijayawada.</b>
DRAWING NO.	: SE / APTRANSCO / 400KV-BMK / 41 / 23-24	

SH.NO.	DESCRIPTION	SHEET NO.
01	COVER & INDEX SHEET	01
02	GENERAL TECHNICAL SPECIFICATION	02 - 03
03	SINGLE LINE DIAGRAM	04 - 06
04	DIMENSIONAL DRAWING	07 - 08
05	BILL OF MATERIAI	09

Drawing approval subject to valid vendor registration

DESIGN & MFD BY : M/S.SRINIVASA ENTERPRISES B-5, T.I.E. BALANAGAR HYDERABAD-500 037 PH.NO.092463 78045 EMAIL: somana123@yahoo.com	<table border="1" style="width: 100%; border-collapse: collapse;"> <tr> <th>NAME</th> <th>SIGN</th> <th>DATE</th> <th>SCALE</th> </tr> <tr> <td>DRN. Bindu</td> <td></td> <td>12-03-2024</td> <td>UNITS</td> </tr> <tr> <td>DGN. Narasimham</td> <td></td> <td>12-03-2024</td> <td></td> </tr> <tr> <td>APPD. S.S.Rao</td> <td></td> <td>12-03-2024</td> <td></td> </tr> </table>	NAME	SIGN	DATE	SCALE	DRN. Bindu		12-03-2024	UNITS	DGN. Narasimham		12-03-2024		APPD. S.S.Rao		12-03-2024	
NAME	SIGN	DATE	SCALE														
DRN. Bindu		12-03-2024	UNITS														
DGN. Narasimham		12-03-2024															
APPD. S.S.Rao		12-03-2024															
TITLE : 400KV BAY MARSHALLING KIOSK		DRAWING NO : SE / APTRANSCO / 400KV-BMK / 41 / 23-24															
		Sheet No : 01      No.of sheets : 09															

(ALL DIMENSIONS ARE IN mm)

## GENERAL TECHNICAL SPECIFICATION

1. (a) Type of Panel : Non-Drawout Type  
 : Non Compartmentlised structure  
 : Construction Double front  
 : Outdoor
- (b) Type of Mounting : Floor mounting
2. Cable Entry : Bottom (Incoming/outgoing)
3. Thickness of Gland Plate : 3mm AL alloy material
4. Busbars : AL bus bar
5. Earth Busbar Size : 25X10 AL bus bar
6. Control wiring with flexible copper conductor PVC insulated wires, 1.1kv grade.
  - (a) AC Voltage circuit : 2.5 Sq.mm (Red, Yellow, Blue, Black)
  - (b) AC Current circuit : 2.5 Sq.mm (Red, Yellow, Blue)
  - (c) Earthing : 2.5 Sq.mm (Green) for all components
  - (d) DC control circuit : 2.5 Sq.mm (Grey)
  - (e) AC control circuit : 2.5 Sq.mm (Black)
7. Minimum size of Power wiring, 1.1kv grade (Flexible conductors)
  - (a) Up to 10A : 2.5 Sq.mm, Copper
  - (b) Up to 24A : 4 Sq.mm, Copper
  - (c) Up to 30A : 6 Sq.mm, Copper
  - (d) Up to 40A : 10 Sq.mm, Copper
  - (e) Up to 63A : 16 Sq.mm, Copper
8. PVC Tag Ferrules : 2.5 Sq.mm PVC with No's

NOTE: 1. DRAWING APPROVAL SUBJECT TO VALID TYPE TEST REPORTS, TO BE CHECKED DURING ACCEPTANCE TESTS  
 2. FOR EPC CONTRACTS ONLY

**Chief Engineer/Projects**  
**APTRANSCO/VS/Vijayawada.**

DESIGN & MFD BY : M/S.SRINIVASA ENTERPRISES B-5, T.I.E. BALANAGAR HYDERABAD-500 037 PH.NO.092463 78045 EMAIL: somana123@yahoo.com	<table border="1" style="width: 100%; border-collapse: collapse;"> <tr> <th>DRN.</th> <th>NAME</th> <th>SIGN</th> <th>DATE</th> <th>SCALE</th> </tr> <tr> <td></td> <td>Bindu</td> <td></td> <td>12-03-2024</td> <td>UNITS</td> </tr> <tr> <td></td> <td>Narasimham</td> <td></td> <td>12-03-2024</td> <td></td> </tr> <tr> <td></td> <td>S.S.Rao</td> <td></td> <td>12-03-2024</td> <td></td> </tr> </table>	DRN.	NAME	SIGN	DATE	SCALE		Bindu		12-03-2024	UNITS		Narasimham		12-03-2024			S.S.Rao		12-03-2024	
DRN.	NAME	SIGN	DATE	SCALE																	
	Bindu		12-03-2024	UNITS																	
	Narasimham		12-03-2024																		
	S.S.Rao		12-03-2024																		
TITLE : 400KV BAY MARSHALLING KIOSK																					
DRAWING NO : SE / APTRANSCO / 400KV-BMK / 41 / 23-24																					
Sheet No : 02      No.of sheets : 09																					

(ALL DIMENSIONS ARE IN mm)

## GENERAL TECHNICAL SPECIFICATION

NOTE: 1. DRAWING APPROVAL SUBJECT TO VALID TYPE TEST

REPORTS, TO BE CHECKED DURING ACCEPTANCE TESTS

2. FOR EPC CONTRACTS ONLY

9. Enclosure Protection : IP-55 as per the IS 13947

10. Test Voltage (IS: 8623 Part-1)

(a) Insulation test : 500V Megger Power & Control

(b) High Voltage test : 2.5kv for 60 seconds

11. Gasket Type : EPDM rubber

12. Red, Yellow, Blue and Black heat shrinkable sleeves shall be used for busbars

13. Panel shall generally confirm to IS:8623

14. All Metallic cases of Doors will be earthed with 2.5 Sq.mm Green Flexible Copper Wire

15. Paint shade : Out side-Light admiralty grey shade no : 631 of IS 5, inside : Glossy white

16. All doors will have pad Locking facility

17. All dimensions are in mm

18. All TBs shall be clearly marked with identification numbers to facilitate external wiring

**Chief Engineer/Projects**  
**APTRANSCO/VS/Vijayawada.**

Drawing approval subject to valid vendor registration

DESIGN & MFD BY :  M/S.SRINIVASA ENTERPRISES B-5, T.I.E. BALANAGAR HYDERABAD-500 037 PH.NO.092463 78045 EMAIL: somana123@yahoo.com	DRN. Bindu DGN. Narasimham APPD. S.S.Rao	SIGN SIGN SIGN	DATE 12-03-2024 12-03-2024 12-03-2024	SCALE UNITS
TITLE : 400KV BAY MARSHALLING KIOSK		DRAWING NO : SE / APTRANSCO / 400KV-BMK / 41 / 23-24 Sheet No : 03    No.of sheets : 09		

NOTE: 1. DRAWING APPROVAL SUBJECT TO VALID TYPE TEST REPORTS, TO BE CHECKED DURING ACCEPTANCE TESTS  
 2. FOR EPC CONTRACTS ONLY

(ALL DIMENSIONS ARE IN mm)

**400KV BAY MARSHALLING KIOSK**

**Chief Engineer/Projects  
 APTRANSCO/VS/Vijayawada.**

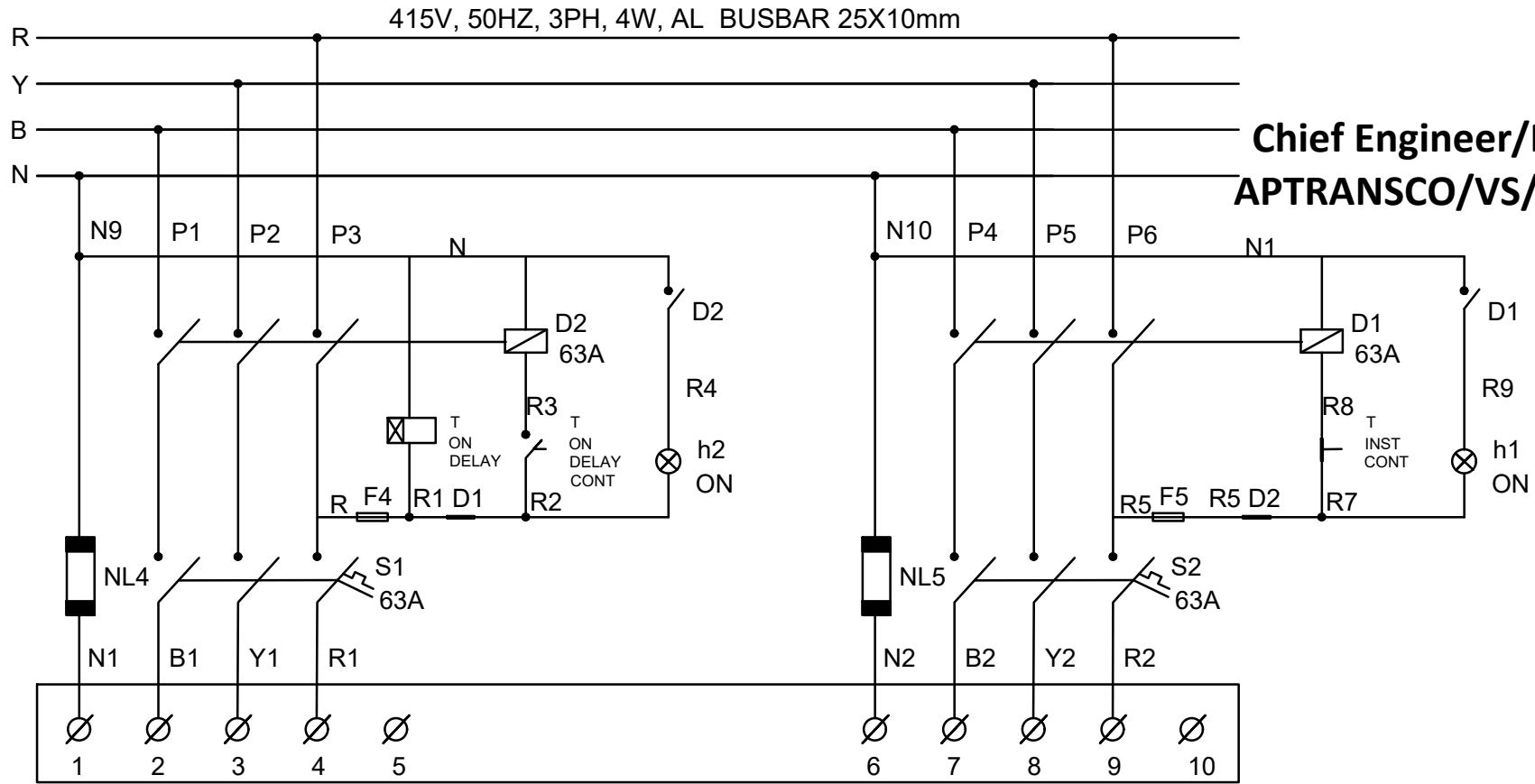

Drawing approval subject to valid vendor registration

DESIGN & MFD BY :		NAME	SIGN	DATE	SCALE
M/S.SRINIVASA ENTERPRISES		Bindu		12-03-2024	UNITS
B-5, T.I.E. BALANAGAR					
HYDERABAD-500 037		DGN:	Narasimham	12-03-2024	
PH.NO.092463 78045		APPD:	S.S.Rao	12-03-2024	
EMAIL: somana123@yahoo.com		DRAWING NO :			
TITLE :		SE / APTRANSCO / 400KV-BMK / 41 / 23-24			
400KV BAY MARSHALLING KIOSK		Sheet No : 04		No.of sheets : 09	

NOTE: 1. DRAWING APPROVAL SUBJECT TO VALID TYPE TEST REPORTS, TO BE CHECKED DURING ACCEPTANCE TESTS  
 2. FOR EPC CONTRACTS ONLY

(ALL DIMENSIONS ARE IN mm)

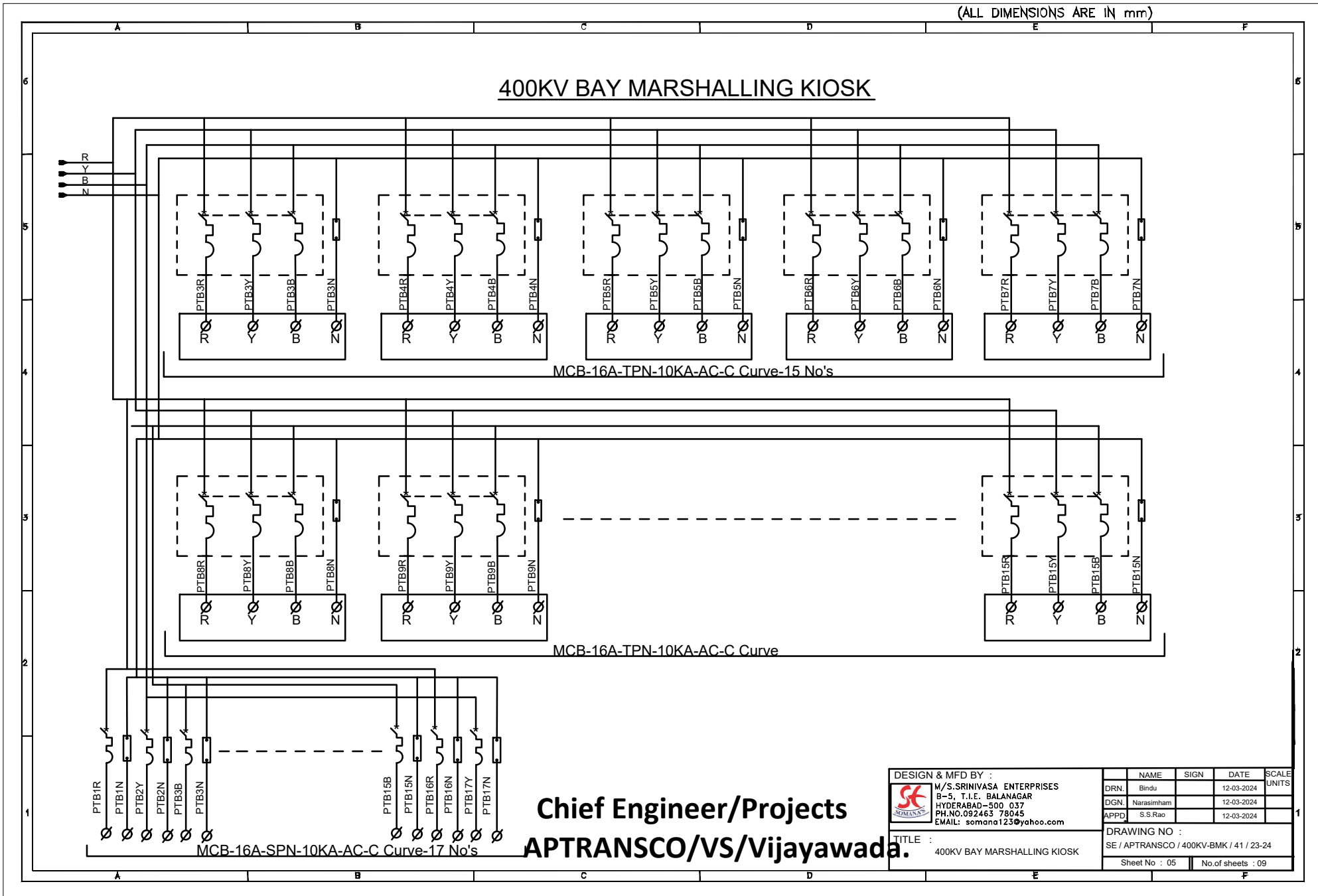

**Chief Engineer/Projects**  
**APTRANSCO/Vs/Vijayawada.**

DESIGN & MFD BY :	M/S.SRINIVASA ENTERPRISES	NAME	SIGN	DATE	SCALE
	B-5, T.I.E. BALANAGAR	DRN.	Bindu	12-03-2024	UNITS
	HYDERABAD-500 037	DGN.	Narasimham	12-03-2024	
	PH.NO.092463 78045	APPD.	S.S.Rao	12-03-2024	
	EMAIL: somana123@yahoo.com	DRAWING NO :			
TITLE :		SE / APTRANSCO / 400KV-BMK / 41 / 23-24			
400KV BAY MARSHALLING KIOSK		Sheet No : 05		No.of sheets : 09	

(ALL DIMENSIONS ARE IN mm)

HEATER, SOCKET, DOOR LAMP CKT

TERMINAL BLOCK-100 No's

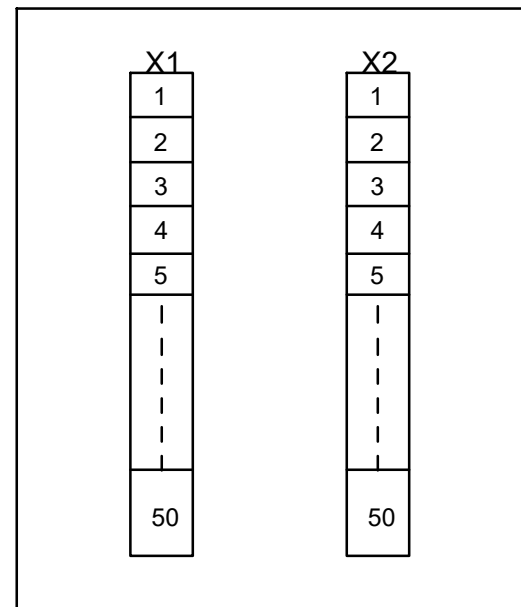
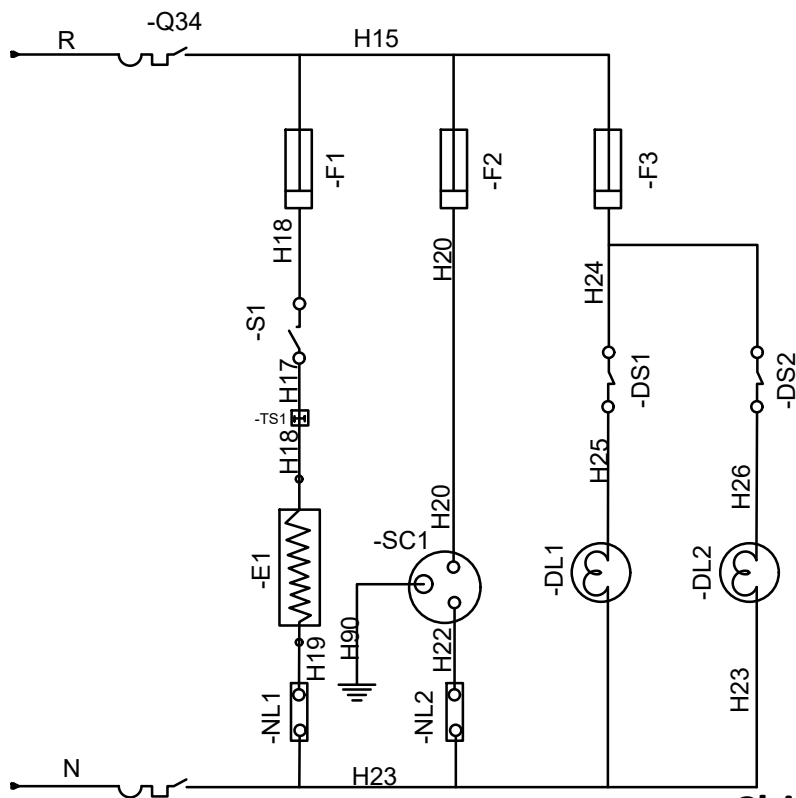

**Chief Engineer/Projects  
APTRANSCO/VS/Vijayawada.**

Drawing approval subject to valid vendor registration

NOTE: 1. DRAWING APPROVAL SUBJECT TO VALID TYPE TEST

REPORTS, TO BE CHECKED DURING ACCEPTANCE TESTS

2. FOR EPC CONTRACTS ONLY

DESIGN & MFD BY :	M/S.SRINIVASA ENTERPRISES	NAME	SIGN	DATE	SCALE
	B-5, T.I.E. BALANAGAR	DRN.	Bindu	12-03-2024	UNITS
	HYDERABAD-500 037	DGN.	Narasimham	12-03-2024	
	PH.NO.092463 78045	APPD.	S.S.Rao	12-03-2024	
	EMAIL: somana123@yahoo.com	DRAWING NO : SE / APTRANSCO / 400KV-BMK / 41 / 23-24			
TITLE : 400KV BAY MARSHALLING KIOSK		Sheet No : 06 No.of sheets : 09			

(ALL DIMENSIONS ARE IN mm)

NOTE: 1. DRAWING APPROVAL SUBJECT TO VALID TYPE TEST REPORTS, TO BE CHECKED DURING ACCEPTANCE TESTS  
2. FOR EPC CONTRACTS ONLY

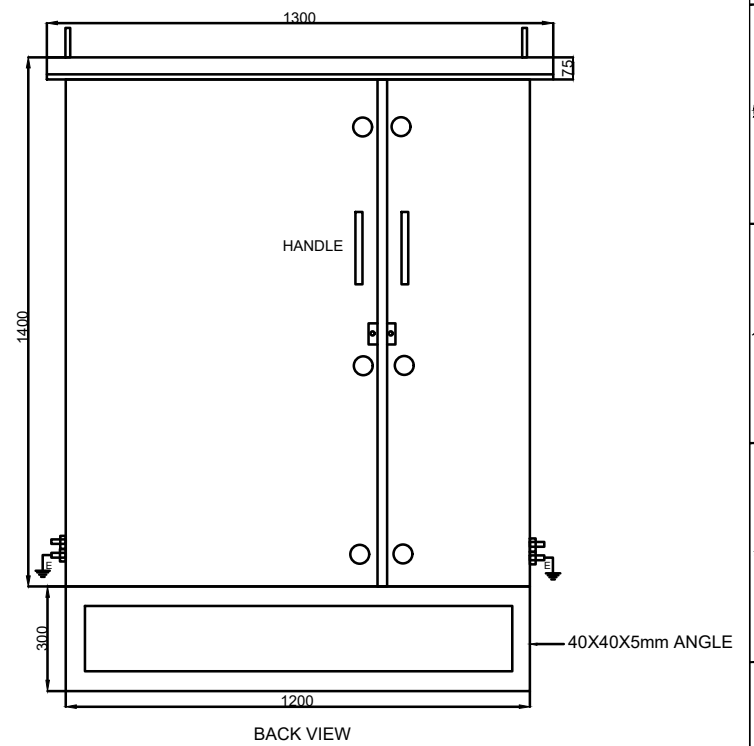
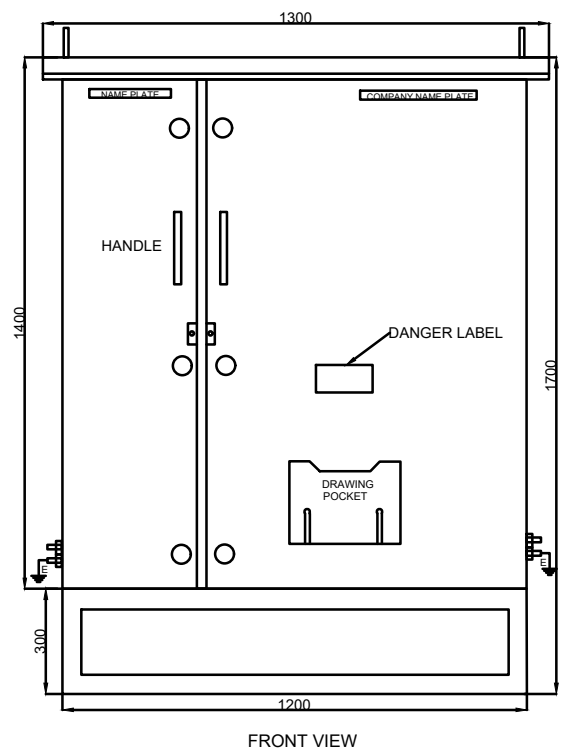
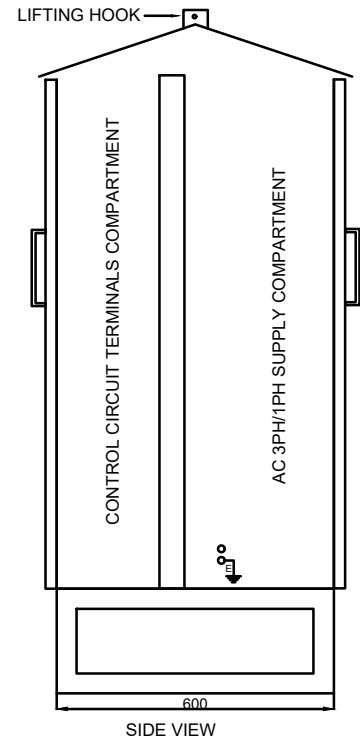

Drawing approval subject to valid vendor registration

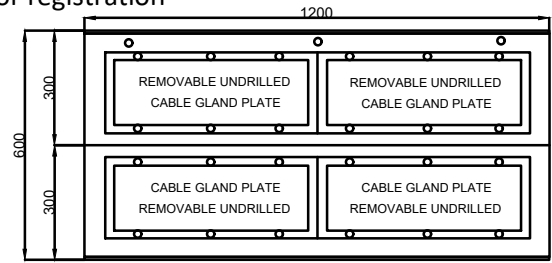

**Chief Engineer/Projects**  
**APTRANSCO/VS/Vijayawada**

DESIGN & MFD BY :		NAME	SIGN	DATE	SCALE
M/S.SRINIVASA ENTERPRISES		Bindu		12-03-2024	UNITS
B-5, T.I.E. BALANAGAR		DGN.	Narasimham	12-03-2024	
HYDERABAD-500 037		APPD.	S.S.Rao	12-03-2024	
PH.NO.092463 78045		DRAWING NO :			
EMAIL: somana123@yahoo.com		SE / APTRANSCO / 400KV-BMK / 41 / 23-24			
TITLE :		Sheet No : 07		No.of sheets : 09	
400KV BAY MARSHALLING KIOSK					

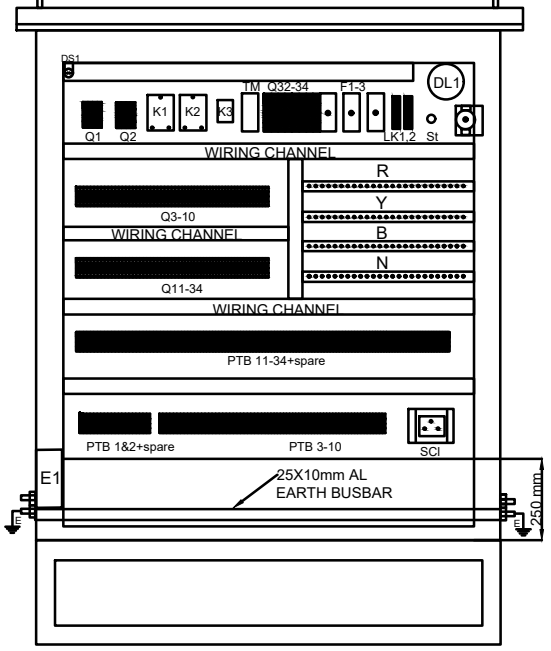

FRONT VIEW  
( DOOR OPEN )  
( TENTATIVE )

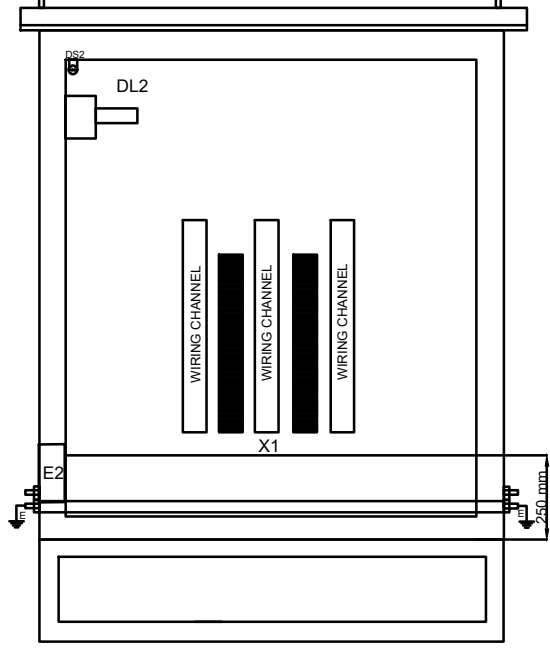

BACK VIEW  
( DOOR OPEN )  
( TENTATIVE )

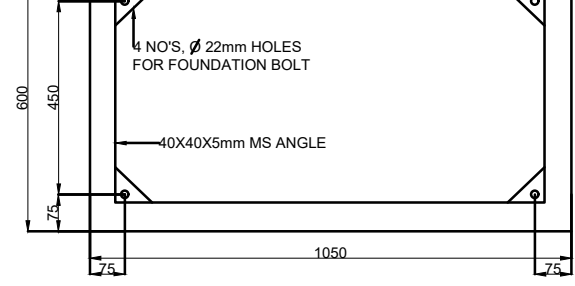

FOUNDATION PLAN

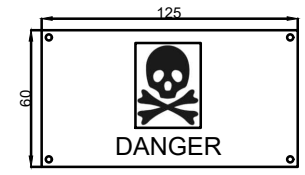

DANGER LABEL N 1.ENGLISH, 2.HINDI

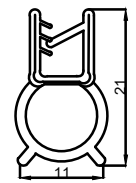

CROSS SECTIONAL VIEW OF GASKET EPDM

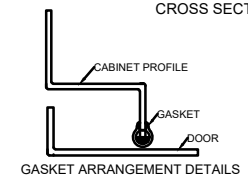

GASKET ARRANGEMENT DETAILS

Drawing approval subject to valid vendor registration

NOTE: 1. DRAWING APPROVAL SUBJECT TO VALID TYPE TEST REPORTS, TO BE CHECKED DURING ACCEPTANCE TESTS  
2. FOR EPC CONTRACTS ONLY

DESIGN & MFD BY :		NAME	SIGN	DATE	SCALE
M/S.SRINIVASA ENTERPRISES B-5, T.I.E. BALANAGAR HYDERABAD-500 037 PH.NO.092463 78045 EMAIL: somana123@yahoo.com	DRN.	Bindu		12-03-2024	UNITS
	DGN.	Narasimham		12-03-2024	
	APPD.	S.S.Rao		12-03-2024	
TITLE :		DRAWING NO :			
400KV BAY MARSHALLING KIOSK		SE / APTRANSCO / 400KV-BMK / 41 / 23-24			
		Sheet No : 08	No.of sheets : 09		

**Chief Engineer/Projects**  
**APTRANSCO/VS/Vijayawada.**

(ALL DIMENSIONS ARE IN mm)

NOTE: 1. DRAWING APPROVAL SUBJECT TO VALID TYPE TEST REPORTS, TO BE CHECKED DURING ACCEPTANCE TESTS  
2. FOR EPC CONTRACTS ONLY

BILL OF MATERIAL				
SL.NO	CIRCUIT DESIGNATION	DESCRIPTION	TOTAL QTY	MAKE
1	DL(1-2)	BULB HOLDER	2	STD VENDOR
2	DL(1-2)	DOORLAMP- CFL-18W-230V AC	2	STD VENDOR
3	DS(1-2)	PB-DOOR LAMP-NC-(REFRIG SWITCH)	2	STD VENDOR
4	E1	SPACE HEATER-80W-230VAC	1	GIRISHEGO / REPUTED
5	F(1-3)	HRC FUSE LINK-6A	3	FTC / BUSSMAN / REPUTED
6	F(1-3)	FUSE BASE-20A-550V AC	3	FTC / BUSSMAN / REPUTED
7	H1 / 2	CLUSTERED LED-ASSLY-240V AC-22.5mm-RED	2	ESBEE /FTC/SIBASS/REPUTED
8	D1,D2	CONTACTOR-63A-240V AC COIL-2NO+2NC	2	C&S / L&T / SALZER / ELMEASURE
9	NL(1-2)	DISCONNECTING TYPE NEUTRAL LINK-63A	2	STD VENDOR
10	PTB(3-34),12 SPARE	TERMINAL BLOCK-POWER-57A-SINGLE-M4	140	ELMEX-CBT M4 / CONNECTWELL
11	Q(1-2)	MCB-63A-TPN-10KA-AC-C CURVE	2	C&S / L&T / SALZER / HAVELLS
12	Q(18-35)	MCB-16A-SPN-10KA-AC-C CURVE	17	C&S / L&T / SALZER / HAVELLS
13	Q(3-17)	MCB-16A-TPN-10KA-AC-C CURVE	15	C&S / L&T / SALZER / HAVELLS
14	Q(36-39)	MCB-6A-2P-10KA-AC-C CURVE	4	C&S / L&T / SALZER / HAVELLS
15	Q40	MCB-10A-2P-AC-10KA-AC-C CURVE	1	C&S / L&T / SALZER / HAVELLS
16	S1	TOGGLE SWITCH-PM-SPST-ON/OFF-6A	1	STD VENDOR
17	SC1	PLUG & SOCKE-240V, 20A, 2P+E	1	LEGRAND / C&S / ANCHOR
18	TM1	TIMER-0.15 TO 10 HRS-2C/O-24V-240V ON DELAY	1	L&T-MICON-2AODTS / C&S
19	TS1	THERMOSTAT-(30-85)C-15A-250V A+1NC+BRACK	1	GIRISHEGO / REPUTED
20	X1	TERMINAL BLOCK-POWER-44A-SINGLE	100	ELMEX-CST6 / CONNECTWELL
21	X2,2 SPARE	TERMINAL BLOCK-POWER-32A-SINGLE	6	ELMEX-CST2.5 / CONNECTWELL

Drawing approval subject to valid vendor registration

**Chief Engineer/Projects**  
**APTRANSCO/VS/Vijayawada.**

DESIGN & MFD BY :		NAME	SIGN	DATE	SCALE
 M/S. SRINIVASA ENTERPRISES B-5, T.I.E. BALANAGAR HYDERABAD-500 037 PH.NO.092463 78045 EMAIL: somana123@yahoo.com	DRN.	Bindu		12-03-2024	UNITS
	DGN.	Narasimham		12-03-2024	
	APPD.	S.S.Rao		12-03-2024	
TITLE :		DRAWING NO :			
400KV BAY MARSHALLING KIOSK		SE / APTRANSCO / 400KV-BMK / 41 / 23-24			
		Sheet No : 09		No.of sheets : 09	